

Project: \_\_\_\_\_  
 Customer: \_\_\_\_\_  
 Tru-Brix Order Number: \_\_\_\_\_  
 Plant: CUSHWA Color: \_\_\_\_\_ Size: Oversize  
 Date: 11/4/09 By: D. ARTZ II Page: \_\_\_\_\_  
 Drawing Name: WATERTABLE 3 Reference: \_\_\_\_\_

**Tru-Brix**<sup>®</sup>  
 Real Brick Siding

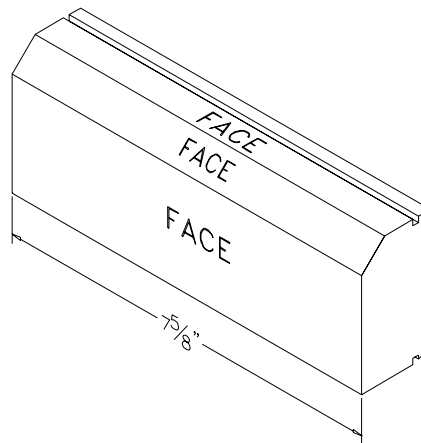
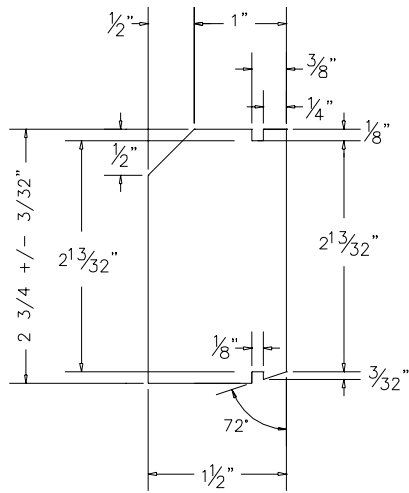

H:\ARTZ II\Tru-Brix\Standard Shapes\Watertable 3.dwg

BELOW LINE FOR REDLAND'S USE ONLY:

AUTHORIZED FOR PRODUCTION BY:

DATE: